

BLÜCHER®

KITCHEN CHANNELS ON BOARD



K E E P I N G U P T H E F L O W

STAINLESS STEEL DRAINAGE SYSTEMS



CHANNELS ON BOARD

At BLÜCHER we have more than 40 years of experience with stainless steel drainage systems, and hygienic solutions for the food industry is one of our specialities.

The combination of stainless steel and careful product design gives you many advantages.

Hygienic

Stainless steel has a smooth surface which is easy to clean, and the BLÜCHER® products are designed without cavities and corners inside leaving no space for deposits.

Accessories like removable water traps also contribute to fast and easy cleaning.

Stable

The BLÜCHER® Channel product program is produced largely from 2 mm stainless steel providing the highest levels of stability and durability.

Fire resistant

Stainless steel is a fire resistant material.

Easy connection

BLÜCHER® Channel fits into the BLÜCHER® Drain Marine lower parts which fit into the lightweight drainage pipe-work system BLÜCHER® EuroPipe.

Shear resistant

The high tensile strength of stainless steel makes the system resistant to shear breakage and cracking.

Temperature resistant

Discharge of liquids at temperatures up to 120 °C will not influence the material.

100% recyclable

Stainless steel is 100% recyclable and is with its long life environmentally friendly. BLÜCHER® Channel is made from stainless steel which has a recycled content over 70% scrap.



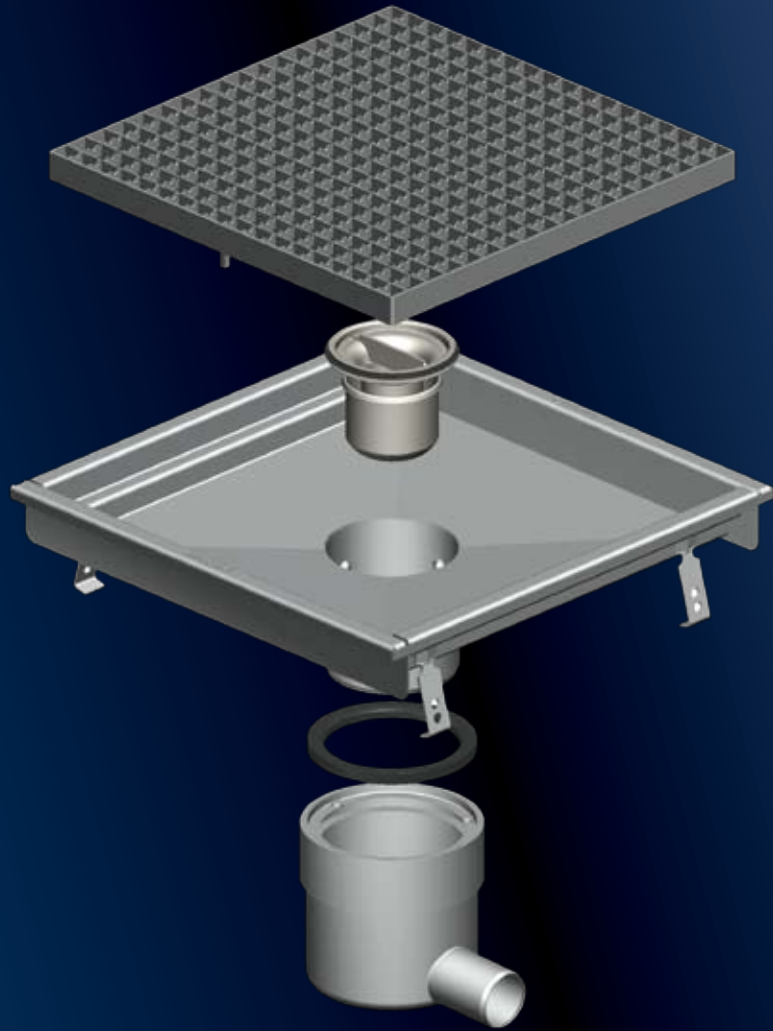

PRODUCT RANGE

The BLÜCHER® Channel program includes a complete range of channels and kitchen channels for tiled or vinyl floors. On board BLÜCHER recommends the use of AISI 316L stainless steel because using this steel quality, the risk of corrosion, caused by an aggressive environment and salt water, is significantly reduced or eliminated entirely.

Freedom of choice with standard solutions

All products are combinable with the BLÜCHER® Drain range of floor drains. All accessories like gratings and water traps are also part of the standard program. Among the numerous advantages of the BLÜCHER® Channel range are:

- Removable water trap for easy cleaning
- Perfect surface finish
- Gratings for any load class

Our technical experts are always willing to assist you in selecting the right channel for your requirements, based on water flow, waste products, weight load and floor covering.

Customised solutions

We are specialised in customised solutions. Please contact us, and we will make a solution fulfilling exactly your requirements. For instance:

- Corners and T-pieces
- Customised lengths and widths
- Customised designs
- Channels for other floor types
- Other gratings

Installation

Standard and special solutions are based on the same modular system ensuring simple and quick installation. The channel is connected to one or more welded deck penetrations by means of push-fit joints. Following this, the drainage solution is completed with water trap, filter bucket and grating.



Selected kitchen channels

Kitchen channel type 660 for tiled floors

| Type No. | Description | F | F1 | I | I1 | D | H | H5 |
|---------------|-------------|------|-----|-----|-----|-----|-------------|------------|
| 660FH004-06 S | 400x400 | 437 | 437 | 397 | 397 | 110 | 145/195/235 | 60/110/150 |
| 660FH008-06 S | 400x800 | 837 | 437 | 797 | 397 | 110 | 145/195/235 | 60/110/150 |
| 660GH005-06 S | 500x500 | 537 | 537 | 497 | 497 | 110 | 145/195/235 | 60/110/150 |
| 660GH010-06 S | 500x1000 | 1037 | 537 | 997 | 497 | 110 | 145/195/235 | 60/110/150 |

Also available in depth H1 110 mm or 150 mm

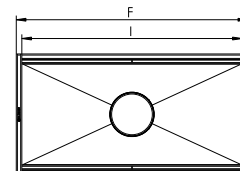
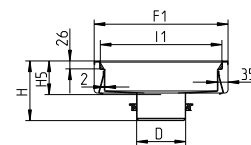

Kitchen channel type 662 for vinyl floors

| Type No. | Description | F | F1 | I | I1 | D | H | H5 |
|---------------|-------------|------|-----|-----|-----|-----|-------------|------------|
| 662FH004-06 S | 400x400 | 437 | 437 | 397 | 397 | 110 | 145/195/235 | 60/110/150 |
| 662FH008-06 S | 400x800 | 837 | 437 | 797 | 397 | 110 | 145/195/235 | 60/110/150 |
| 662GH005-06 S | 500x500 | 537 | 537 | 497 | 497 | 110 | 145/195/235 | 60/110/150 |
| 662GH010-06 S | 500x1000 | 1037 | 537 | 997 | 497 | 110 | 145/195/235 | 60/110/150 |

Also available in depth H1 110 mm or 150 mm

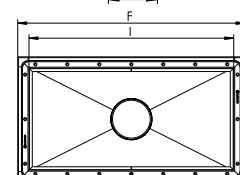
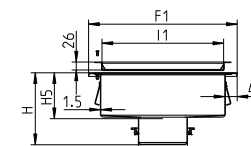

Selected gratings for kitchen channels

| Type No. | Description | LxW | H |
|-------------------|--------------|---------|----|
| 696.223.394.395 S | Mesh grating | 394x394 | 25 |
| 696.223.494.495 S | Mesh grating | 494x494 | 25 |

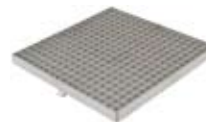

Accessories for kitchen channels

| Type No. | Description | S | D | D2 | H5 | H | Flow l/sec. |
|-----------------|-----------------------------|----|-----|----|----|-----|-------------|
| 502.052.110 CRS | Water trap | 52 | 108 | 75 | - | 93 | 0.9-1.2 |
| 503.000.110 | Multi water trap | 51 | 108 | 75 | 93 | 113 | 0.9-1.3 |
| IG.054CR* | Sealing ring for lower part | | | | | | |

*Must be used when a lower part is installed

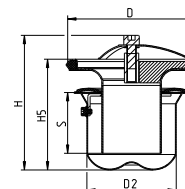
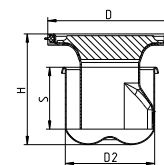

Selected lower parts with MED certificate

Ⓢ = MED certificate

Lower part with vertical outlet and welding sleeve

| Type No. | | X | D1 | D2 | Kg |
|---------------|----------|-----|-----|-----|-----|
| 470.000.050 S | Ⓢ A0-A60 | 174 | 50 | 150 | 1.6 |
| 470.000.075 S | | 172 | 75 | 150 | 1.6 |
| 470.000.110 S | | 145 | 110 | 150 | 1.5 |

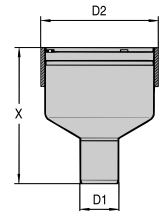

Lower part with vertical outlet and welding flange

| Type No. | | D1 | D2 | D3 | X | Kg |
|---------------|----------|-----|-----|-----|-----|-----|
| 470.200.050 S | Ⓢ A0-A60 | 50 | 140 | 200 | 174 | 1.3 |
| 470.200.075 S | | 75 | 140 | 200 | 172 | 1.4 |
| 470.200.110 S | | 110 | 140 | 200 | 145 | 1.3 |

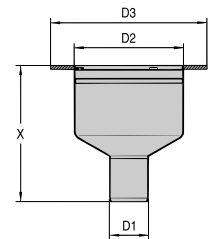

Lower part with horizontal outlet and welding sleeve

| Type No. | | D1 | D2 | X1 | X2 | B | Kg |
|---------------|----------|----|-----|-----|-----|-----|-----|
| 475.000.050 S | Ⓢ A0-A60 | 50 | 150 | 117 | 140 | 199 | 1.9 |
| 475.000.075 S | | 75 | 150 | 105 | 140 | 204 | 1.8 |

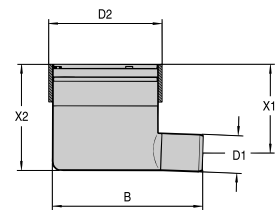

Lower part with horizontal outlet and welding sleeve, extended height

| Type No. | | D1 | D2 | X1 | X2 | B | Kg |
|---------------|----------|----|-----|-----|-----|-----|-----|
| 475.100.050 S | Ⓢ A0-A60 | 50 | 150 | 187 | 164 | 199 | 2.1 |

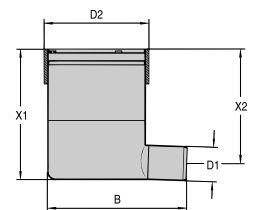

Lower part with horizontal outlet and welding flange

| Type No. | | D1 | D2 | D3 | X1 | X2 | B | Kg |
|---------------|----------|----|-----|-----|-----|----|-----|-----|
| 475.200.050 S | Ⓢ A0-A60 | 50 | 140 | 200 | 106 | 72 | 199 | 1.3 |
| 475.200.075 S | | 75 | 140 | 200 | 106 | 70 | 204 | 1.4 |

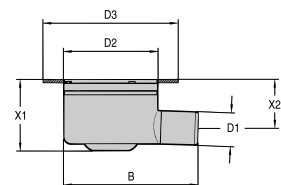

All measurements in mm

BLÜCHER®

At BLÜCHER® more than 300 employees create an annual turnover of more than 50 million euro.

Through know-how, dedicated service and common sense we develop, produce and market high quality stainless steel drainage solutions for customers within the housing, commercial, industrial and marine sectors all over the world.

Find your local BLÜCHER® specialist at www.blucher.com

BLÜCHER® EuroPipe

BLÜCHER® Channel

BLÜCHER® Drain



KEEPING UP THE FLOW