

Product sheet



INDUSTRIAL DRAIN, LOW
- Floor: concrete and tiled
- Frame: 300x300mm
- Outlet: Ø75mm, vertical
- Stainless steel: AISI304/EN1.4301

DATA

Type no.: 766.403.075
EAN no.: 5705499110302
VVS no.:
RSK no.:
NRF no.:
LVI no.: 3303551

Floor: Concrete/tiled
Shape: Square
Membrane type: No membrane
Outlet direction: Vertical
Size: 300x300
Outlet dia. (mm): 75
Min. height (mm): 273
No. of holes for screws: 0
Weight (kg): 4,75
Material: EN 1.4301
Material: AISI 304
Adjustable: No

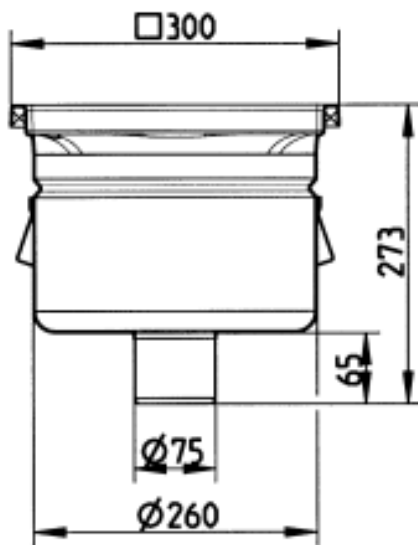

Approvals

DK - VA 2.42/17378

DK - VA 2.42/19497

NO - 0461

Ru - 0882648 Product Certificate Drain & accessories POCC DK.MX03.H01387

